

Doors & Technical issues

Internal Doors for Domestic
and Commercial Use





Experience doors...

Index	Laminated Surfaces	Page 3	Handles	Page 14
	Treated Surfaces	Page 4	Performance Doors	Page 15
	Door Leaves	Page 6	Security, Acoustic and Climate Barrier Doors	Page 16
	Door Frames	Page 7	Material Options	Page 17
	Sliding and Swing Doors	Page 8	Fire Rated Doors	Page 18
	Ceiling Heights	Page 9	Radiation	Page 20
	Double Doors	Page 10	Wet Rooms	Page 21
	Glass Systems	Page 11	Measurements for One & Two Leaf Doors	Page 22
	Glass Inserts	Page 12	Measurements for Glass Doors	Page 23
	Fittings	Page 13		



Attention to Detail

There is a lot more to a single door at first sight. The vast range of options that we offer in the design enable you to create a high quality and long lasting door. Great attention is paid to even the smallest of details resulting in increasingly popular products.



Veneer Surfaces

We offer a vast range of finishes including Beech, Maple, Oak and more. With our product you will find only the highest quality workmanship and materials.

With ringo you are able to choose from a magnitude of surfaces, dimensions, finishes and frames – we offer a solution for every design.



Model Quer
shown in Beech

Model Quadra
shown in Beech

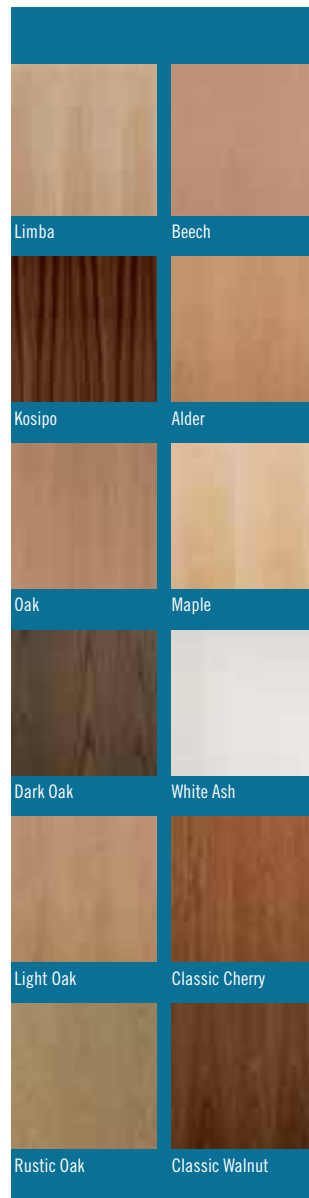

Surface Variations

Techniques choosing individual colour and grain ensure that no two veneers are the same which in turn proves the authenticity of the veneer. In the content of this brochure you will notice the 'Classic' & 'Rustic' have been used which means that the veneers have been colour treated.

Surfaces

ringodor – is our label for decorative foils. These are uniquely coloured wood productions or with a particular logo imprinted onto the design, perhaps even with a resin finish.

ringolit – Our label for Laminate used frequently in the door and furniture industry. This surface is also highly resistant to household chemicals.

ringotex – this is the alternative label for decorative foils; the characteristics of this smooth surface ensure that the mechanics and hygiene are a feature, which makes them ideal for use in kitchens or commercial buildings. Again these are uniquely coloured wood productions or with a particular logo imprinted onto the design, perhaps even with a resin finish.



Beech (1) (2) (3)

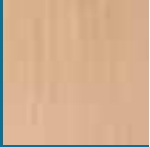

Maple (1) (2) (3)



Oak (1) (2) (3)

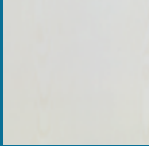

Durable White Ash (2) (3)



White Ash (1) (2) (3)

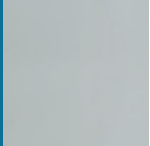

Pearl Grey (2) (3)

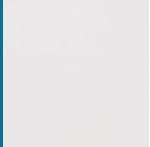

Pearl White (2) (3)

All of the above finishes are available in:
 (1) ringodor
 (2) ringolit
 (3) ringotex



ringolit surface shown in Maple



ringodor surface shown in Beech



ringotex surface shown in Blue



Scratch Resistant



Fade Resistant



Heat Resistant

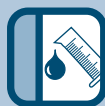

Acid Resistant



Solvent Resistant



Stain Resistant



Abrasion Resistant

Varnish Surfaces

The Colour Spectrum

The colour spectrum available offers a large range of modern colours. The most commonly used finish for the surfaces is pearl, however other RAL colours are available.

Primer

There are many lacquers to be applied to a primed door, some of these include; Resin, Acrylic Lacquer, DD Lacquer and SH Lacquer. Every care has been taken to ensure that over-lacquering does not occur to give an unsatisfactory appearance.

The frames manufactured from laminated plywood then primed. The primer contains a UV block to prevent discolouring over time.

White Lacquer (RAL 9010)



Door and Frame both shown with rounded profiles

White Lacquer

This finish is made up of multi-layers of white varnish (RAL 9010) foil coat. Special hardening lacquers are used in layers to create the scratch proof surface which is easy to keep clean.

The varnished used is non harmful to the atmosphere. Different layers of varnish can obtain a lighter or darker shade depending on preference.

Construction Features

There are many features of the doors to show the quality of their construction:

- Gluing during the laminate process is in accordance with DIN EN 204 (stress group D3).
- Also care has been taken to ensure that there are different capabilities of the doors depending on the situation they are to be used in. This in turn means that In-Doors are able to offer sound, heat, and radiation resistant panels along with security and acoustic models.

Panels

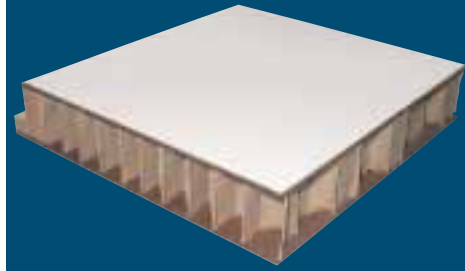

'Enclosure' Model with honeycomb core shown finished in white lacquer (Weight 9 kg/m²)

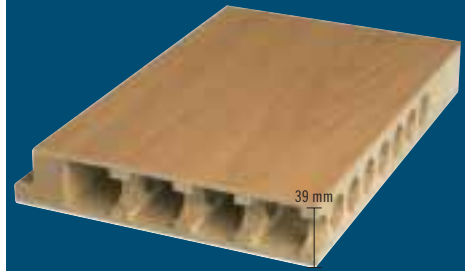

'Ideal' Model with hollow core (Weight 12 kg/m²)

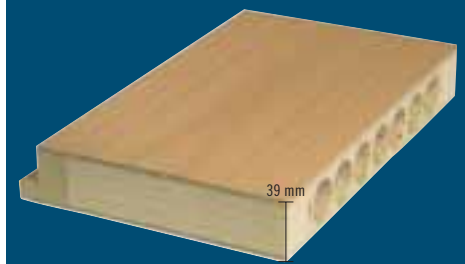

'Perfect' Model with hollow chipboard core (Weight 16 kg/m²)

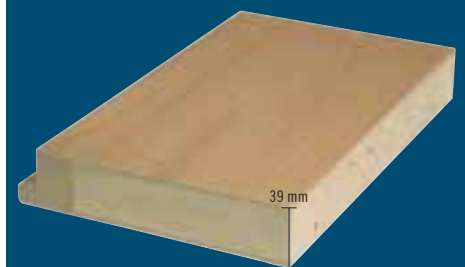

'Special' Model with solid chipboard core (Weight 23 Kg/m²)

Variations on Profiles

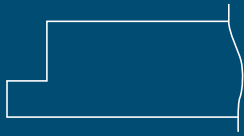

E



R

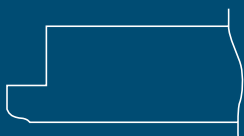

K

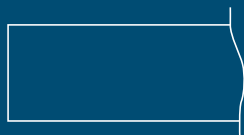

square

Door Leaves

Panels confirm to all the necessary standards such as DIN E 68706 Part 1 and DIN 18101 for dimensions. They have also passed all stress and climatic tests in accordance with RAL RG 426. The key locks available conform to DIN 18251.



Door and Frame showing curved profile

Frame features of ringo

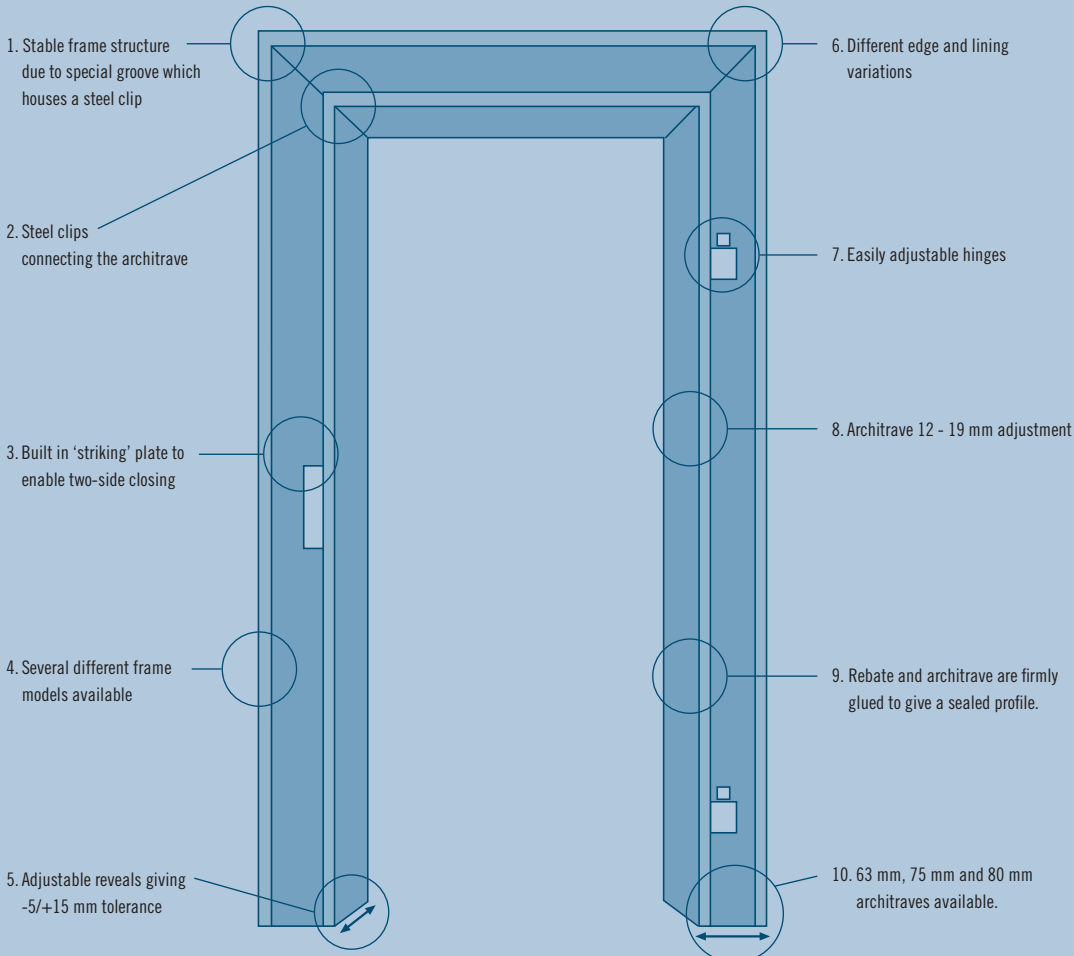

Variations

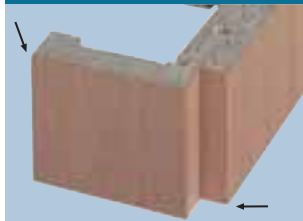

EE – Corner edged architrave and jamb

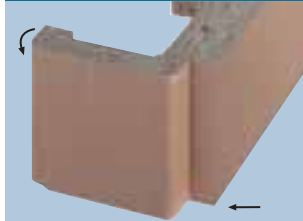

RE – Round edged architrave and corner edged jamb



RR – Round edged architrave and jamb

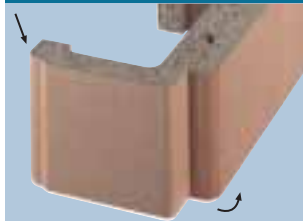

KR – Indented edged architrave and round edged jamb

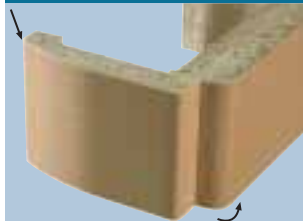

FR – Planed round edged architrave and round edged jamb

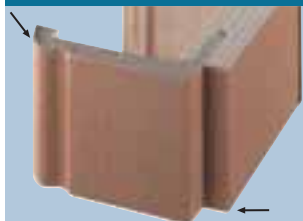

MASSIVE FRAME TOP M PE – Profiled edged architrave and round edge jamb



MASSIVE FRAME TOP M RR – Round edged architrave and jamb

Frames

Frame type top in accordance with DIN 68706 Part 2

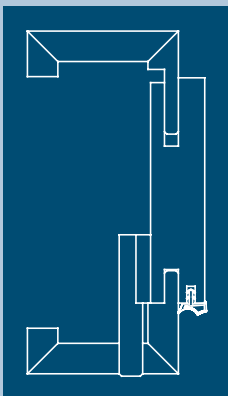

Frame - TOP Model

Ready to fit with standard dimensions in accordance with DIN 18101.

No standard dimensions are also available.

Material Strength: 22 mm Jamb

Architrave Deep: 12/13 mm adjustable to 19 mm

Architrave Width: 63 mm varying to 75 mm to corner of mitre

Striking plate secured for 2 way folding

Hinge connections with 4 point stress hinges V 3400 WF

Draught Excluder

Wall thickness -5/+15 mm

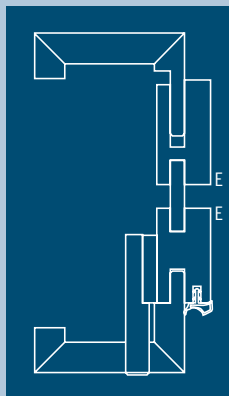

Frame TOP expansion joint

From 501 mm wall thickness

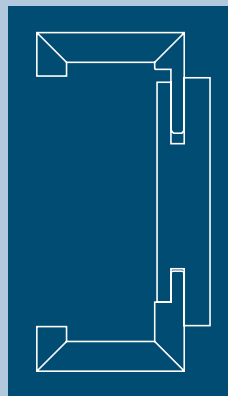

Frame TOP Passage

Shown without Ironmongery and Draught Excluder

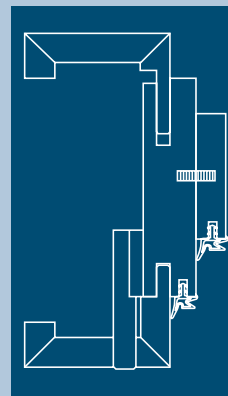

Frame TOP with double rebate

Doubled to approximately 12 mm for second door rebate (variable)

Striking Plate fitted (52808 H)

Hinge connection fitted (BAB01)

Hinges (V 4400 WF)

2 Draught excluder strips

Sliding and Swing Doors

Sliding Door Panels

- Manufactured in accordance with DIN E68706 Part 1
- Standard dimensions conform to DIN 18101
- Each door leaf is approximately 39 mm thick
- Grooves in floor for sliding panel
- Pull handle both sides for ease of opening
- Both timber and plate glass options are available

Sliding Doors – SE 1

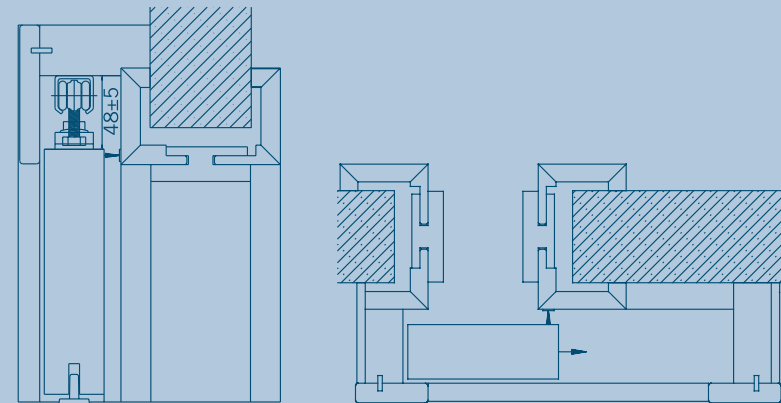

Sliding door panel shown sliding in front of the wall.

Sets can be made to either 735 mm or 860 mm and are delivered complete with all jambs, dowel screws, handles and other necessary items.

Sliding Doors – SE 2

Sliding door panel shown running into the wall with tandem running mechanism

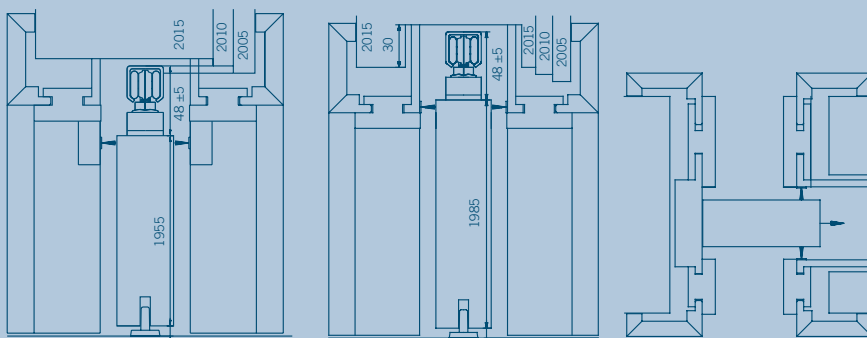

Swing Door Panels

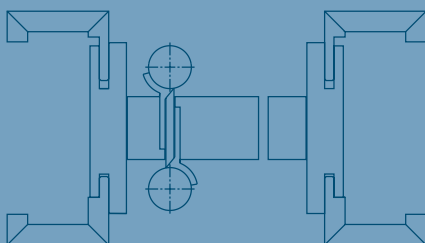

- Standard dimensions conform to DIN 18101
- Architrave approximately 63 mm (varying to 75 mm)
- Glued in accordance with DIN EN 204 D3
- Delivered fully packaged



Ceiling Heights

Single or double doors are available with fixed glazing above which conforms to all current building regulations.

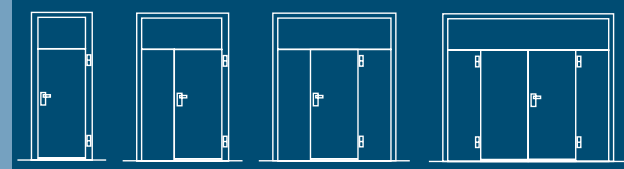

Floor to ceiling solid doors with over-lights shown as single or double door arrangements

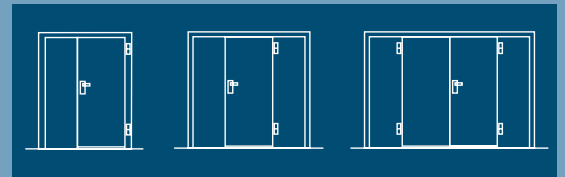

Floor to ceiling solid doors without over-lights shown as single or double door arrangements



Floor to ceiling glazed doors without over-lights shown as single or double door arrangements



Floor to ceiling glazed doors with over-lights shown as single or double door arrangements

Arched Panels

Arched panels can be manufactured in veneered, lacquered or white painted surfaces.



Single leaves shown with Arched, Roman Arched or Rounded head frames



Double Doors indicating Arched, Roman Arched and Rounded head frames

Double Doors

The lead panel and slave door are usually the same width however other combinations are possible. Doors are also available with an opening door and fixed (dummy) panel adjoining to give the illusion of double opening doors.

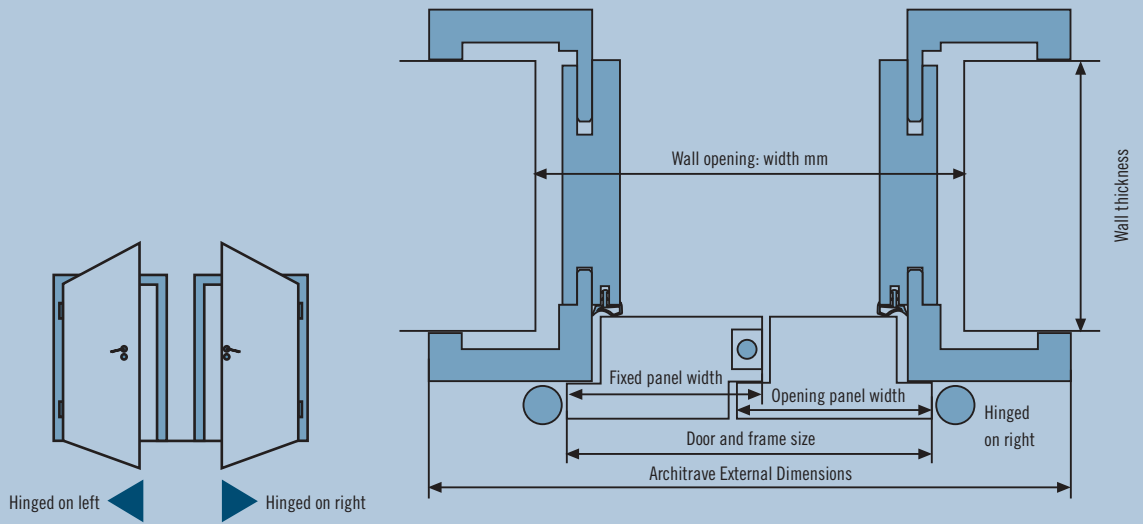

Designs

One Design for Different Models

The same glass design is often used on many different door models. For instance one may prefer a solid door to a living area with acoustic qualities and a glass door to a kitchen or dining area to achieve optimum lighting.

All doors shown below have the TOP door frame and safety glass.

Combinations of doors and glass with 'Astro' Design



...with standard glazed opening

...with special glazed opening

...as Vitrum door

...or as all-glass door

Glass Designs



Clear and obscure glass



Frosted glass with raised designs



Frosted glass with raised 'reed' detail

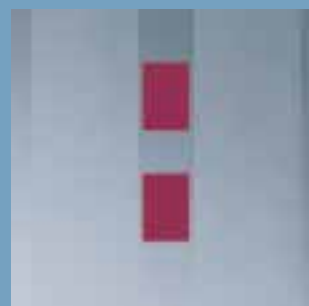

Coloured Squares
(3 colours available)

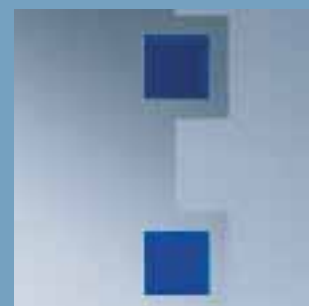

Coloured glass additions applied on top of the glass (3 colours available)

- All glass used is toughened safety glass.
- Clear and coloured glass options are available each with alternative designs.
- Using obscure glass is an excellent option to prevent fingerprints or marks.

Glass Inserts

- In accordance with Din E 68706 Part 1 (July 2000)



Example shown as 860mm

Standard dimensions of doors with glass inserts in accordance with Din E 68706 Part 1 (July 2000)															
Overall Width mm	415			478			540			603		665			
Door Leaf Width mm	704 -	735	- 766	767	-	828	829 -	860	- 891	892	-	953	954 -	985	- 1016
Overall Height mm	1425						1550								
Door Leaf Height mm	1923 -	1985	- 2047	2048 -	2110	- 2172									

- Standard door widths (735/860/985) x Overall Height (1985) available in flat packed or loose.

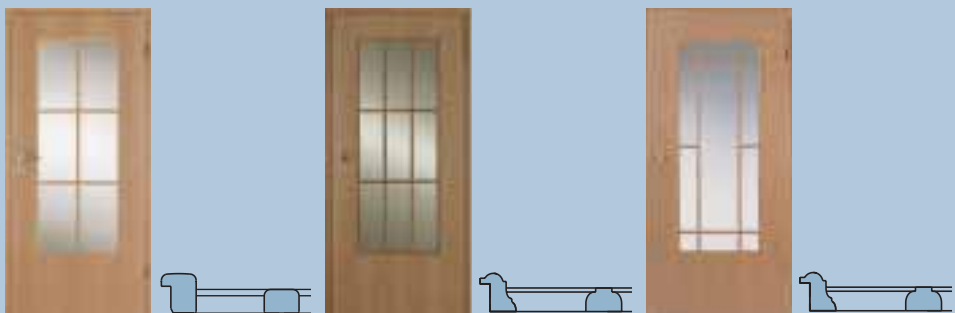

C1
Finished surface; available in Beech, Alder, Maple, White Ash, Birch, Natural Ash, Light Grey Ash and White Lacquer (RAL 9010)

C2
Primed surface; available in Limba, Kosipo, Oak, Light Oak, Dark Oak, Pine, Spruce, Rustic Cherry and Rustic Walnut

SP N1
Primed surface; available in Limba, Kosipo, Oak, Light Oak, Beech, Maple, White Ash, Dark Oak, Pine, Spruce, White lacquer (RAL 9010), Rustic Cherry and Rustic Walnut

Glass Insert Variations

- For door heights of 1985 mm or 2110 mm the frame is loose packed without the glass
- Glass beads need to be glued into place
- Surfaces available are as follows: Light Oak, Beech, Alder, Maple, Light Maple, White Ash, White lacquer (RAL 9010), coloured lacquer from the ringo colour range.

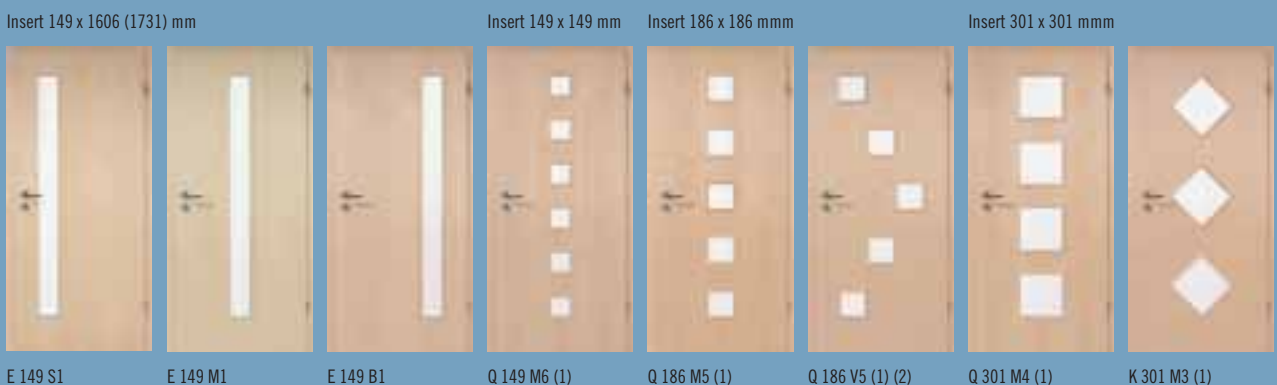
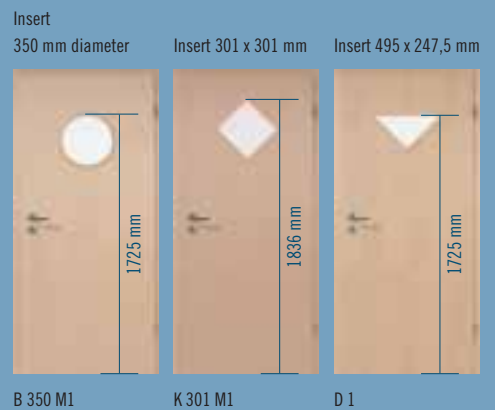

(1) Door Leaf height only available at 2110 mm wide

(2) Door Leaf width only available at 860 mm wide

Fittings

Different furniture is available depending on the situation be it domestic or commercial.

Hinges and hinge supports

Different hinges are also available for differing strengths and types of doors

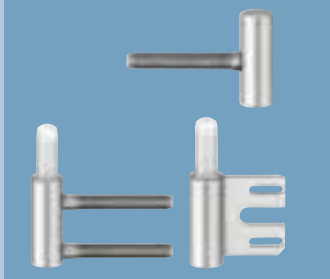

V 3420 WF Wood or V 8120 WF Steel (Standards)

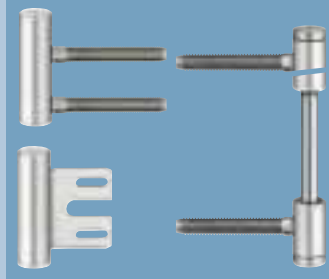

V 4426 WF Wood or V 8026 WF Steel

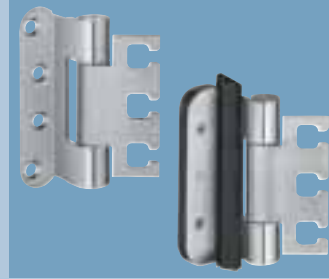

VX 7939/100 Wood and Steel (variation to cover the rebate)

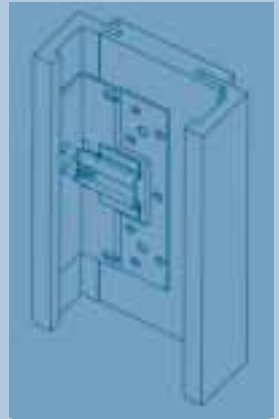

BAB 01

For higher door weights (i.e. glass doors @ 20 kg/m²) we would advise use of the frame with the WF Wood hinges and a steel right angle plate to keep the frame square.

Locks



Class 1
Standard lock for use in a bathroom (55 mm)



Class 3
Standard security lock

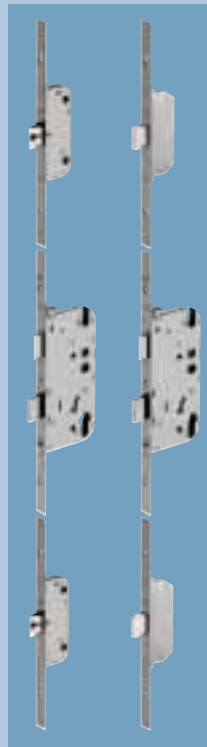

Multi lock
3 point locking for high security

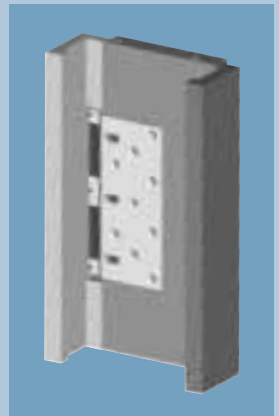

Lock Plate S 2808 H

Handles



Handle set of single doors



Handle set for double doors



Hinge (Model – Arcos)



Hinge for single door (Model – Arcos Office)

Lock plates



If a locking handle is required we advise that the lock plate is changed to the 2808 FA Model.



Lock Plate Model 408 G

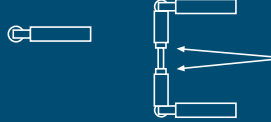

GG Furniture for glass doors with adjustable spindle

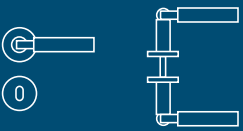

BB Furniture with mortise lock

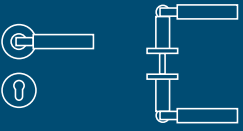

PZ Furniture with profile cylinder lock

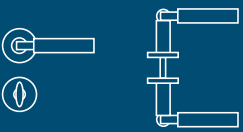

WC Furniture for bathrooms



WL/WR Changeable furniture depending if the door is hinged on the left or right

Handles

We offer a choice of 3 surfaces:

- **Chrome** - for a modern look
- **Stainless steel** – for commercial applications
- **Polished Brass** – for a more traditional look

Technical Description

Each handle set for the wooden doors comes complete with a rosette to surround the handle and key lock.

Designed for ease of fitting with no modification required.

The handle set can be used for wooden doors...



San Remo

Modena



Bologna

Portofino

...and with appropriate fittings for all-glass doors!



Elba

Rimini

other models for wood and all-glass doors



Modena Fresato

Udine

Assisi

Torino

Orvieto

Vicenza

Genova vertical escutcheon (for wood doors only)

Palermo

Como

Venezia blanco

Genova

Lecce

Milano

Parma

Napoli

Venezia color



Performance Doors

Multi-functional doors for optimum safety

ringo doors have been designed to take into account acoustics, security and climate to create a vast of performance doors choice to suit the situation. All test results are available upon request.



Security doors can have a composite of wood and steel frames or just steel. Every performance door is available in all finishes mentioned previously in this brochure.



Burglar resistant



Suitable for apartment entrance doors



Climate resistant



Sound resistant



Abrasion resistant



Radiation resistant



Fire resistant



Spy Hole



Multiple lock



Security catch



Ideal for a Flat Entrance door with key locking in accordance with DIN 18257



Tests

- **Multi-functional**

Panels with wooden frames

Panels with steel frames

Panels with steel corner frames
- **Conform with security standard DIN V ENV 1627**

security class WK 2

security class WK 3
- **Sound proof in accordance with DIN 4109**

Sound proof class 1 $R_{WP} = 32 \text{ dB} - R_{WR} = 27 \text{ dB}$

Sound proof class 2 $R_{WP} = 37 \text{ dB} - R_{WR} = 32 \text{ dB}$

Sound proof class 3 $R_{WP} = 42 \text{ dB} - R_{WR} = 37 \text{ dB}$
- **Climate protections in accordance with RAL-RG 426 Part 1**

Climate Class II

Climate Class III



Security in accordance with DIN V ENV 1627

Criteria for security classes		Where we advise the security would be most appropriate		
		A Domestic	B Public place ie; apartments	C commercial applications
Resistance-Classes	Prevention against break ins and Vandalism potential vandalism situations			
WK 1	Basic protection against vandalism such as kicking, punching and forcing the door. This class only offers light protection against use of crow bar. It is more likely that this class of door would be used in an internal application			
WK 2	Offers light protection against pre-meditated vandalism with of tools.			
WK 3	Offers medium protection against pre-meditated vandalism with of tools.			
WK 4	Protection against more determined thieves equipped with specialist tools i.e. saws, chisels hammers and axes etc for burglaries.			
WK 5	Protection against more determined thieves equipped with more specialist tools i.e. electric drills and angle grinders etc for burglaries.			
WK 6	Protection against more determined thieves equipped with more specialist tools i.e. electric drills and angle grinders etc for burglaries.			

Please note – This table gives an overview of which type of doors to use for more at risk areas and situations.

Small risk
 Medium risk
 High risk

Sound Proofing in accordance DIN 4109

Building Type	Areas and rooms between one door and another	
Apartments and Offices	Entrance door into hallway	▶▶ Hallway into living area
	Entrance door into hallway	▶▶ Hallway into living area
Schools and Colleges	Hallway	▶▶ Classrooms
Hotels	Hallway	▶▶ Bedrooms
Hospitals	Examining Room	▶▶ Examining Room
	Hallway	▶▶ Examining Room
	Hallway	▶▶ Hospital Ward
	Operating Theatre	▶▶ Operating Theatre, Ward
	Hallway	▶▶ Operating Theatre, Treatment Room

Climate control in accordance RAL-RG 426 Part 1

Climate category	Test Results	
tested on standard door	Surface Opening	Surface Closed
I	23 °C, 30 % RLF ($U_{gl} \approx 7,5 \%$)	18 °C, 50 % RLF ($U_{gl} \approx 11 \%$)
II	23 °C, 30 % RLF ($U_{gl} \approx 7,5 \%$)	13 °C, 65 % RLF ($U_{gl} \approx 13,2 \%$)
III	23 °C, 30 % RLF ($U_{gl} \approx 7,5 \%$)	3 °C, 85 % RLF ($U_{gl} \approx 16 \%$)

Useage		External Apartment Doors	Internal Doors	Bathroom	Commercial Doors			
					Kindergarden Hospital Hotel-room	Class-rooms Hostel Barracks	Class-rooms Examining Room Office	Kitchen Cantine Laboratory
hygrotermic	I							
	II						4)	
	III							4)
manuell	N							
	M							
	S							4)
	E							4)

- 1) Test certificates have been obtained in accordance with building regulations
- 2) Specification depending on situation in accordance to DIN 4109
- 3) Use of climatic doors is not always required however sometimes steel frames are advised.
- 4) Choice of whether a higher or lower type climatic door is required depends on where it is situated
- 5) Door leaves and frames can be manufactured in accordance with what is required.
In areas with a damp atmosphere or with door leaves where the height in over 2.11 m we advise use of a higher level climatic door.



External Doors

- Burglar proof in accordance with DIN V ENV
- Sound proof in accordance with DIN 4109

The following test results are all for ringo elements, if any of these are altered or changed the test results will no longer be valid.

Assembly must be carried out once the instructions have been read and the correct materials have been obtained to carry out the installation.

Door panels

- Different systems are available for differing purposes and situations
- Easy construction of the outer frame
- Glued in accordance with DIN EN 204 D3
- Choice of designs and surfaces
- Special hardware and construction can be chosen for more commercial applications

Profile Variations

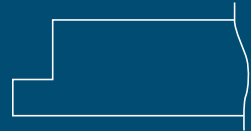

E Angular

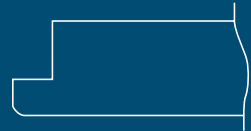

R Rounded (only for 45mm door leaf thickness)

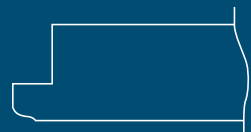

K Curved (only for 45mm door leaf thickness)

External door types

TYP	External door types (WEH, WES)	sound proofing class 1 R _{wP} = 32 dB	sound proofing class 2 R _{wP} = 37 dB	sound proofing class 3 R _{wP} = 42 dB
	Without additional security	WE H 34 II WE S 34 II WE E 34 II	WE H 37 II WE S 37 II WE E 37 II	WE H 42 II WE S 42 II WE E 42 II
	Security Class 2	WE H 34 WK 2 II WE S 34 WK 2 II WE E 34 WK 2 II	WE H 37 WK 2 II WE S 37 WK 2 II WE E 37 WK 2 II	WE H 42 WK 2 II WE S 42 WK 2 II WE E 42 WK 2 II
	Security Class 3		WE H 37 WK 3 II WE S 37 WK 3 II WE E 37 WK 3 II	WE H 42 WK 3 II WE S 42 WK 3 II WE E 42 WK 3 II

Security in accordance with DIN V EN 1627, Climatic Class II, III
 Sound proofing in accordance DIN 52210
 H = Wooden door frame, S = Steel door frame, E = Steel corner frame
 WE = External door panels

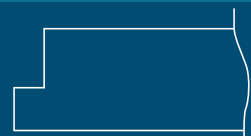

Standard rebate

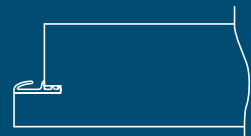

Standard rebate with cover sealing



Non-standard rebate with cover sealing

with wood frame (WEH) in accordance with DIN E 6806 Teil 2

- Flat packed
- Veneered
- Larger architrave available
- Solid construction with corner connections
- Easy to assemble, all connections provided

with Steel frame (WES) or Steel Corner frame (WEE)

- Strong materials for more solid construction
- Choice of door frames
- Draught excluders
- Hardware available for more particular requirements
- Burglar proof classes WK2 & WK3 are only available with the steel corner frame

Variations

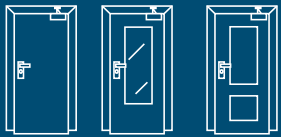

Available with safety glass, extra panels and decorative designs

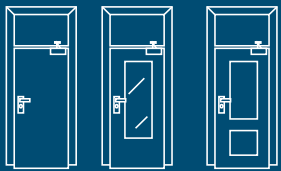

Available with solid fixed lights above, safety glass and decorative designs



Available with glazed fixed lights above, safety glass and decorative designs



Fire Doors

Tested in accordance with DIN 4102



■ Security doors



■ Acoustic doors

Fire doors are available with steel or wooden frames in the same designs as standard internal doors previously featured in this brochure.

The aim of the fire proof door is to add extra resistance to fire which improves time available for escape.

Each ringo fire door is tested for its guaranteed protection functions.

TYP	Door Type	
	fire resistant	
		BR HT 30-1 M/L
		BR ST 30-1 M
		BR ST 30-1 L
		BR HT 30-2 M/L
		BR ST 30-2 M
		BR ST 30-2 L
		BR HT 90-1 M
		BR ST 90-1 M
		BR S T 90-1 L
		BR HT 90-2 M
		BR ST 90-2 M
		M = Solid wall, L = Lighter wall
		Number of door wings
		Fire rating 30/90 minutes
		Door leaf with H = wooden frame, S = steel frame
		BR = Fire resistance



Picture showing fire-rated hinge



Maple select

In-Doors can be used in every situation
Commercial use in Hotel Avidon (Düsseldorf)





Ray Protection

These doors are ideal for use in hospitals and radiology laboratories as they are lead lined to give protection against X-Rays (in accordance with DIN 6834). All finishes from the range are available. They can arrive fully finished in a painted surface for ease of cleaning in hygienic environments or a primed surface ready to paint.



White lacquer (RAL 9010)

Accessories and fittings

Door Panels

Lead thicknesses available 1,0 mm (2 x 0,5 mm),
2,0 mm (2 x 1,0 mm),
3,0 mm (2 x 1,5 mm)

Locks

Available in half and full cylinder locks (40 mm or 80 mm) already included in the door assembly together with lead lining. All locks are manufactured from high grade steel in accordance with all building regulations.

Hinges

Hinge standard = VX 7939 / 160 TZ manufactured from matt Nickel or high grade steel. All hinges come pre-fitted.

Vision Panels

Vision panels available in measurements of: 400 mm wide x 300 mm high or 500 mm wide x 400 mm high.

Vision panels include protective glass to guard against any harmful rays penetrating the glass. When ordering doors with vision panels we require the measurement from the base of the door to the base of the vision panel.

Lock Plate

A steel reinforcing plate is available on the inside of the jamb for heavier door construction.



Damp Rooms

Suitable for use where the atmosphere has a high degree of condensation such as a kitchen. Also available with vision panels and fixed over-lights.

All doors have pre-drilled holes for accessories i.e. hinges and lock plates to make for a straightforward installation.

White lacquer (RAL 9010)



Wet Rooms

Suitable for use where the door may be likely to be splashed i.e. Bathrooms, in-door pools. Also available with vision panels and fixed over-lights.

All doors have pre-drilled holes for accessories i.e. hinges and lock plates to make for a straightforward installation.



Measurements for Single and Double Doors

In accordance with DIN 18100/18101

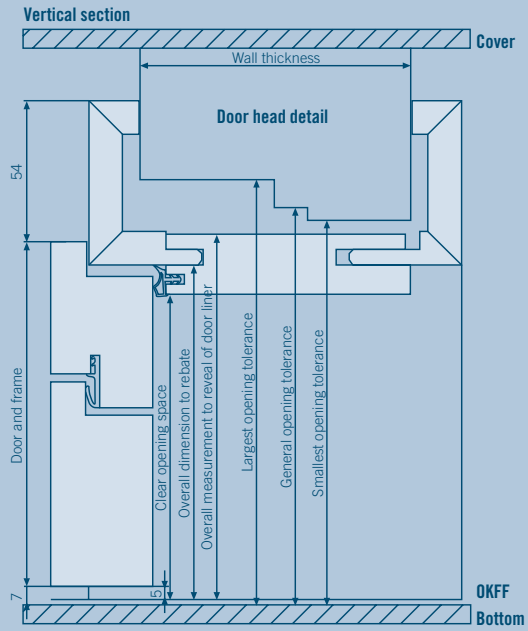
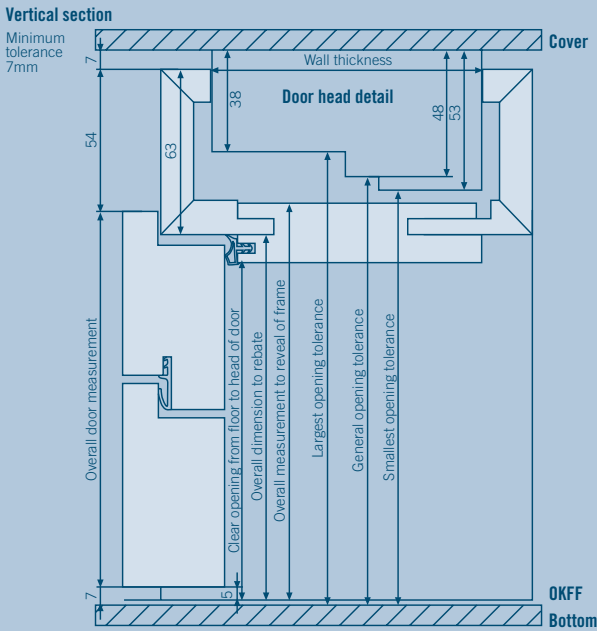
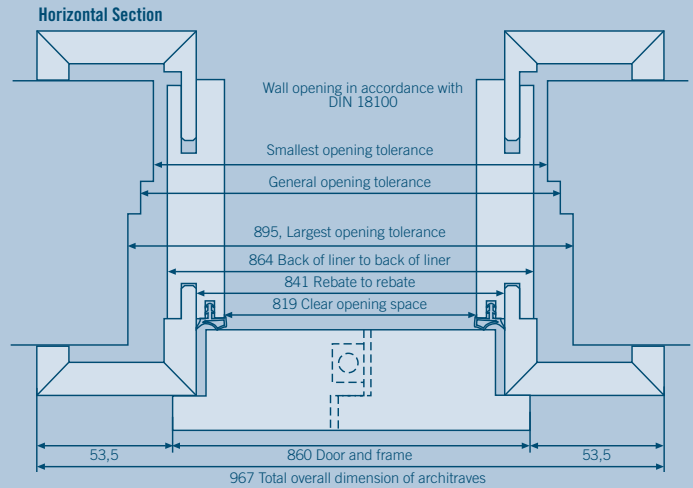
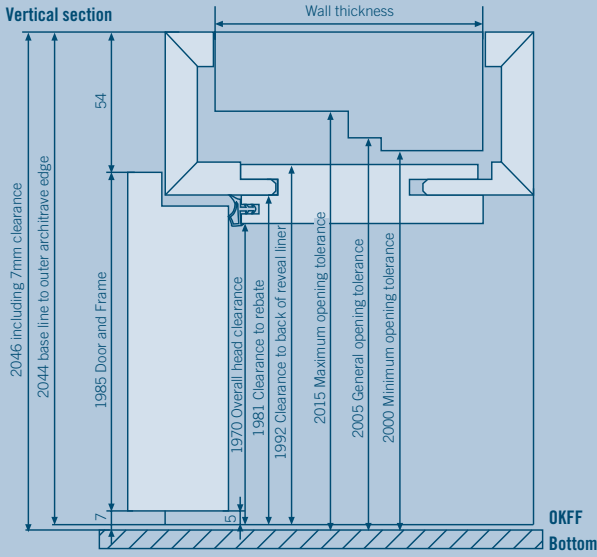

wooden frames TOP	Single Doors						Double Doors			
	Widths				Heights		Widths			
Wall opening	625	750	875	1000	2000	2125	1250	1500	1750	2000
General wall opening	635	760	885	1010	2005	2130	1260	1510	1760	2010
Smallest opening dimension	645	770	895	1020	2015	2140	1250	1500	1750	2000
Architrave	717	842	967	1092	2044	2169	1317	1567	1817	2067
Outside Frame	614	739	864	989	1992	2117	1214	1464	1714	1964
Rebate	591	716	841	966	1981	2106	1191	1441	1691	1941
Frame Opening	569	694	819	944	1970	2095	1169	1419	1669	1919
Door and frame	610	735	860	985	1985	2110	1210	1460	1710	1960
Opening Door							610	735	860	985
Fixed Door							610	735	860	985

Steel Frame	Single Doors						Double Doors			
	Widths				Heights		Widths			
Wall Opening	625	750	875	1000	2000	2125	1250	1500	1750	2000
Frame & Rebate	591	716	841	966	1983	2108	1216	1466	1716	1966
Door and Frame	610	735	860	985	1985	2110	1235	1485	1735	1985
Opening Door							610	735	860	985
Fixed Door							635	760	885	1010

Wall thickness with composite (steel and wood)													
Standard for timber frame													
Order dimension	85	105	125	140	160	180	205	225	250	270	290	325	435
Minimum wall thickness	80	100	120	135	155	175	200	220	245	265	285	320	430
Maximum wall thickness	100	120	140	155	175	195	220	240	265	285	305	340	450

Measurements for Glass Doors

Opening door and fixed panel - Lock plate Arcos, Hinge Arcos,
Horizontal drill holes, Dimensions for actual glass door panel 834 x 1972

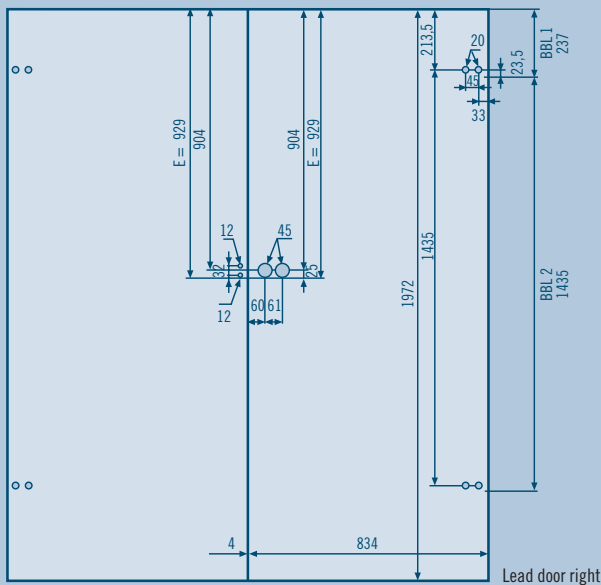

Double Doors - Lock plate Gala, Hinge Gala, Horizontal drill holes
Dimensions for actual glass door panel 834 x 1972

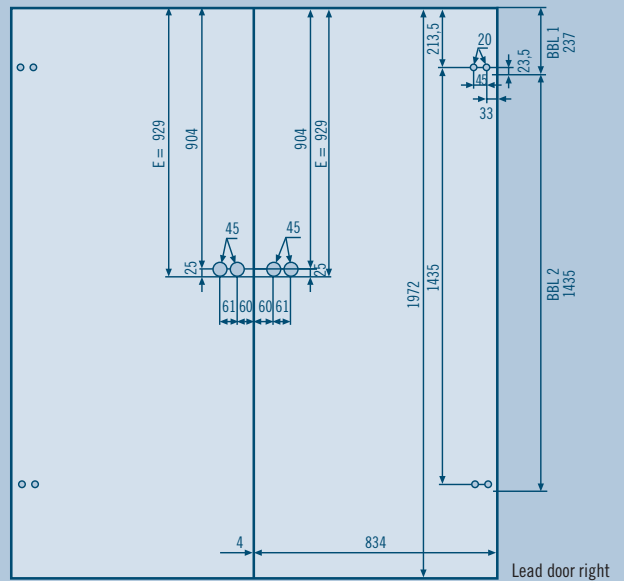

Opening door and fixed panel - Lock plate Arcos-Office, Hinge Arcos-Office,
Vertical drill holes, Dimensions for actual glass door panel 834 x 1972

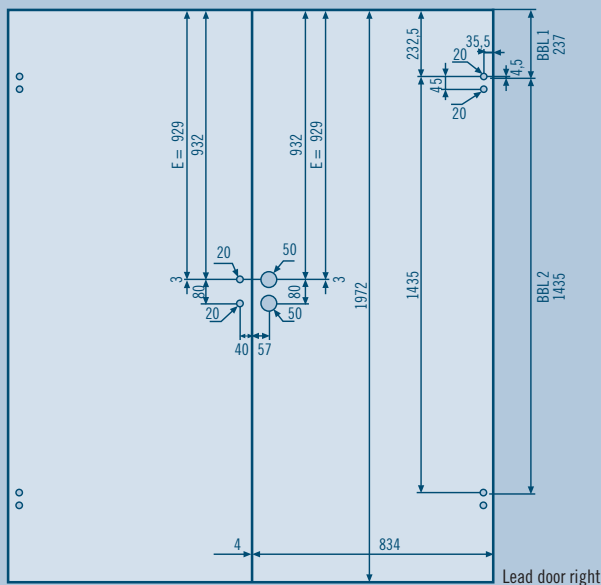

Opening door and fixed panel - Lock plate Arcos, Hinge Arcos-Office, Vertical and Horizontal drill holes, Dimensions for actual glass door panel 834 x 1972

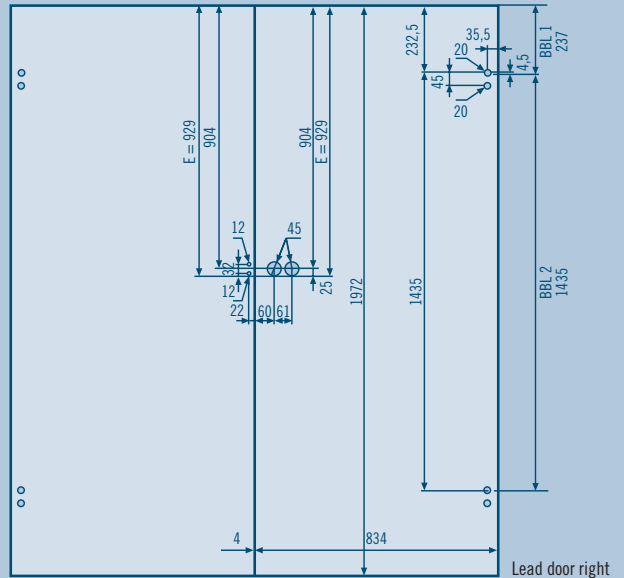

- The structure is always viewed from the inside (applies for both timber and glass doors)
- With double doors the lead panel must always be identified
- Panel weight (inc. safety glass) 20 kg/m²
- The frame needs to be chosen in accordance with the weight of the doors

Wooden Frames	Single Doors						Double Doors			
	Widths			Heights			Widths			
Door and frame measurements	610	735	860	985	1985	2110	1210	1460	1710	1960
Opening glass door	584	709	834	959	1972	2097	1198	1448	1698	1948
Opening Panel							584	709	834	959
Fixed Panel							584	709	834	959
Steel Frames	Single Doors						Double Doors			
	Widths			Heights			Widths			
Door and frame measurements	610	735	860	985	1985	2110	1235	1485	1735	1985
Opening glass door	584	709	834	959	1972	2097	1235	1485	1735	1985
Opening Panel							584	709	834	959
Fixed Panel							621	746	871	996

Out with the **Old** in with the **New**

Here is an example using modern technology to cover old frames giving the door a new look.

A quick an easy solution

Without major reconstruction works it is quick and simple to cover old and tired frames with new door finishes in both laminate and veneer. This modern method of replacing your doors creates a whole new feel to your house and generally takes approximately 2 hours.

In most cases standard door sizes will cover the general opening sizes if not they can easily be manufactured. All old building works will be covered by the clean new lines.

Please inform us of the following when ordering:

- 1 = Overall width of the frame
- 2 = Overall reveal height
- 3 = Wall thickness
- 4 = Overall reveal depth
- 5 = On which side is the door hinged?

